

Unipolar Charge Sensing with Coplanar Electrodes— Application to Semiconductor Detectors

P.N. Luke

Engineering Division, Lawrence Berkeley Laboratory¹
University of California, Berkeley, CA 94720

Abstract

A novel method to perform preferential sensing of single-polarity charge carriers in ionization detectors is presented. It achieves the same function as Frisch grids commonly employed in gas ion chambers but uses a coplanar electrode configuration suitable for semiconductor detectors. Through the use of this method, good energy resolution can be obtained from room-temperature compound semiconductor detectors despite their poor hole-collection characteristics. Experiments using a CdZnTe detector demonstrate the effectiveness of this technique. Schemes to correct for electron trapping and to obtain position information are also described.

I. INTRODUCTION

Radiation detectors based on wide band-gap semiconductors have long been under development as potential room temperature alternatives for cryogenic Si and Ge detectors [1]. Among the various materials studied, CdTe and HgI₂ have undergone the most extensive development. Although detectors have been successfully fabricated from these materials and are used in various applications, there is a continuing effort to develop materials with improved characteristics. Recently, CdZnTe crystals have been produced using the high-pressure Bridgman growth process [2]. This material possesses many of the desirable properties for detector applications, such as high resistivity ($\sim 10^{11}$ ohm-cm) for low leakage-current operation, and the absence of significant polarization effects. The ability to grow large CdZnTe crystals has resulted in detectors with active volumes up to several cubic centimeters [3].

However, despite the considerable progress made in materials development, the charge transport properties of these compound semiconductors are still far from optimal for gamma-ray spectroscopy applications. While the collection efficiency for electrons is generally quite adequate in many of these materials, the collection efficiency for holes is invariably

much worse. The mobility-lifetime products for the holes are typically an order of magnitude less than those for the electrons. This is due in large part to the low hole mobility inherent in most of these compound semiconductors. For a detector with a simple planar electrode configuration, a full amplitude signal is generated from an energy deposition only when both the electrons and holes created in the process are fully collected. When hole collection is incomplete, there will be a deficiency in the detector signal, with the amount of deficit depending on the location of carrier generation with respect to the electrodes. Such depth-dependent signal variations can become very large when the disparity in collection efficiencies between electrons and holes is large, and when the hole collection distance is small compared to the detector thickness. This presents a major problem in attempting to use these detectors for gamma-ray spectroscopy since photons in this energy range are weakly absorbed and thus tend to interact randomly throughout the detector volume. The resulting variations in signal amplitude severely degrade the detector's energy resolution. The situation is worse at higher gamma-ray energies as the absorption coefficient decreases, and thicker detectors are required to achieve significant efficiency.

Several methods have been devised to circumvent the problem of poor hole collection in these detectors. One class of methods involves the use of electronic techniques, which include pulse-shape discrimination [4] and charge-loss compensation [5]. In pulse-shape discrimination, detector signals that exhibit poor charge collection characteristics are rejected. This method can yield a much improved spectral response but results in a large loss in detection efficiency. In the charge-loss compensation method, each detector signal is analyzed and an appropriate correction is then applied to the signal to compensate for the effect of incomplete hole collection. A drawback of this method is the need for sophisticated electronics, which substantially increases the size and power consumption of the detection system. Moreover, both of these electronic methods can be adversely affected by inhomogeneity of the detector material in terms of charge trapping, carrier mobility and electric field distribution, which can produce unpredictable variations in the detector signals. A different method, which does not rely on electronic corrections, makes use of detectors with hemispherical electrodes to achieve a certain degree of preferential electron sensing so that the effects of incomplete hole collection are diminished [6]. However, this method is only partially effective and results in

¹This work was supported by the Director, Office of Energy Research, Office of Biological and Environmental Research, Analytical Technology Division, of the U.S. Department of Energy under Contract No. DE-AC03-76SF00098. Reference to a company or product name does not imply approval or recommendation of the product by the University of California or the U.S. Department of Energy to the exclusion of others that may be suitable.

a highly non-uniform electric field distribution within the detector, which further aggravates the charge collection problem.

The incomplete collection of positively charged carriers is a common problem that is also found in gas and liquid ionization detectors. The primary carriers produced in these detectors are electrons and positive ions. The ions, being much more massive than the electrons, have much lower mobility and are thus generally not fully collected within typical pulse processing times. For these detectors, the classic solution to this charge collection problem is the use of Frisch grids [7]. A Frisch grid consists of a gridded electrode placed inside the detection medium in front of the anode (Fig. 1a). By appropriately biasing the grid and the other electrodes, electrons that are being collected can pass through the grid with high efficiency. The grid provides an electrostatic shield so that the movement of carriers in the region between the cathode and the grid do not induce any significant signal at the anode. Virtually the entire signal is developed after the electrons have passed through the grid and drifted across the space between the grid and the anode (Fig. 1b). Consequently, carriers that are created at any location within the region between the cathode and the grid will always give full-amplitude signals as long as all the electrons are collected at the anode, regardless of whether or not the positive ions are collected. While this unipolar charge-sensing scheme is highly effective and is widely employed in gas and liquid ionization detectors, it is unfortunately not readily applicable to semiconductor detectors because of the obvious difficulties in forming a working Frisch grid structure inside the semiconductor crystal.

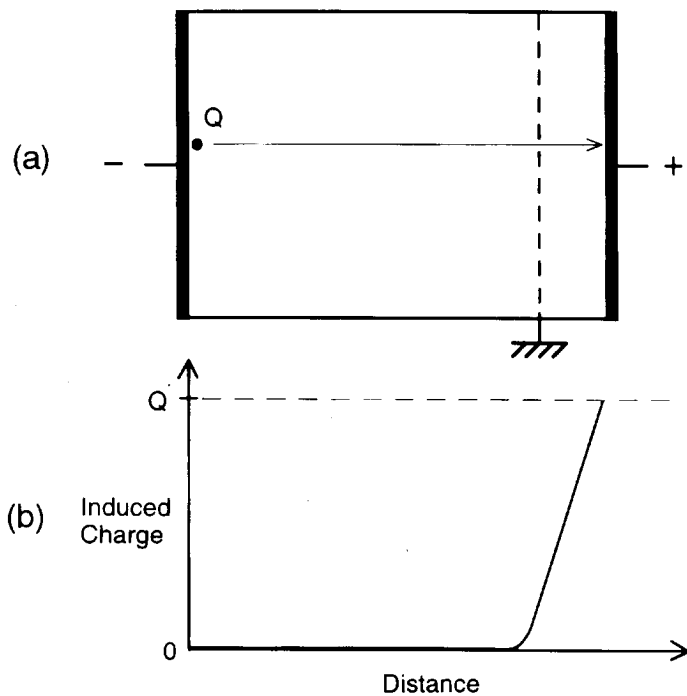

Fig. 1. (a) Basic structure of the Frisch grid. (b) Induced charge at the anode as a function of distance traveled by the charge Q .

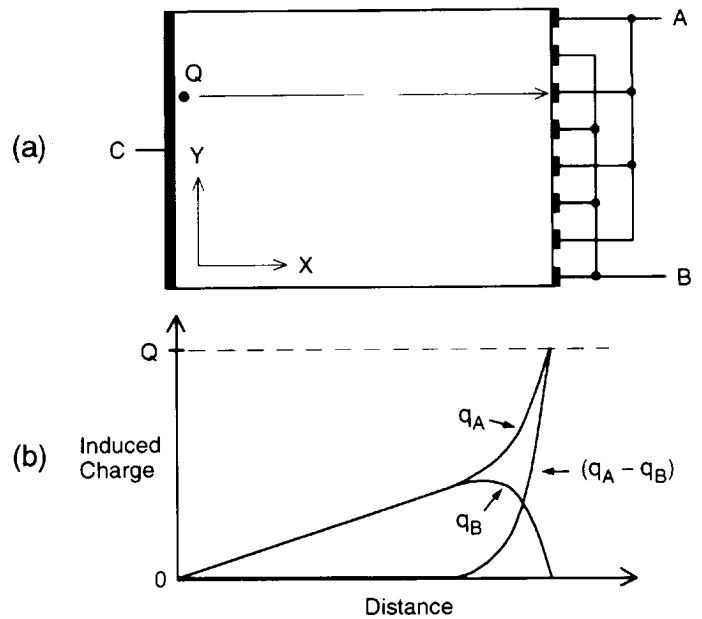

Fig. 2. (a) Basic structure of the coplanar grids. (b) Induced charge at electrode A (q_A), at electrode B (q_B), and the difference signal ($q_A - q_B$) as a function of distance traveled by a charge Q which is ultimately collected at electrode A.

Our group has recently developed a new charge sensing technique that uses coplanar electrodes to achieve the same function as that of Frisch grids [8]. The coplanar electrode arrangement (coplanar grid) allows this method to be readily implemented on semiconductor detectors. Application of this method to compound semiconductor detectors should effectively eliminate the signal degrading effects of poor hole collection and substantially improve their gamma-ray spectral performance.

II. COPLANAR-GRID DETECTION TECHNIQUE

The basic structure of the coplanar grid consists of a series of narrow strip electrodes formed on a detector surface, as shown schematically in an end-on view in Fig. 2a. The strip electrodes are connected in an alternate manner to give two sets of interdigital grid electrodes (A and B). Assume for the moment that both grid electrodes are maintained at the same potential. A uniform electric field for carrier collection can be established inside the detector by applying a different potential to the opposite full-area electrode (C). The signal induced at an electrode due to the movement of a charge carrier can be calculated using the weighing potential method based on the formulation by Ramo [9]:

$$\Delta q = Q \Delta V_w, \quad (1)$$

where Δq is the incremental charge induced at a selected electrode, Q is the charge of the carrier, and ΔV_w is the change in the weighing potential (V_w) over the path of the carrier. The weighing potential is the potential that would exist in the detector with the selected electrode at "unit" potential (dimensionless), all other electrodes at zero potential, and no space charge. It is important to point out that the form of V_w

is generally different from that of the real potential distribution in the detector. This is especially true when the device has more than two independent electrodes, as is the case here. The path of the charge carrier, on the other hand, does depend on the real potential, which is determined by the actual operating potentials at the electrodes, including the effect of any space charge that might be present. The shape of the induced charge signal can be easily visualized by projecting the path of the carrier onto the weighing potential distribution.

The weighing potential for the grid electrode A in Fig. 2a, obtained using finite element analysis, is shown in Fig. 3. By symmetry, the weighing potential for grid electrode B has the same form except that the "potentials" at the two electrodes are interchanged, which obviously would leave the flat portion of the distribution unchanged. In other words, the weighing potential distributions for the two grid electrodes are virtually identical except for a small region near the grid electrodes. Therefore, a charge carrier originating near electrode C and ultimately collected at electrode A will induce equal signals at the two grid electrodes until the carrier is near the end of its path when the signal at the collecting electrode (A) rises steeply to a value equal to the charge of the carrier while the signal at the non-collecting electrode (B) returns to zero (Fig. 2b). The difference of these two signals yields a new signal that does not show significant response for carrier movements over most of the detector volume. This signal closely resembles that obtained using the Frisch grid configuration and a very similar effect is therefore achieved. The distance from the coplanar grids where the difference signal starts to increase significantly is analogous to the grid-to-anode spacing in a Frisch grid configuration. The thickness of this charge-induction region depends primarily on the strip pitch, i.e., the center-to-center distance between adjacent strip electrodes on the detector. Calculations showed that about 95% of the difference signal is developed within a distance from the grid electrode equal to the strip pitch, and 99.7% of the signal is developed within twice the strip pitch. To achieve effective unipolar charge sensing over a large fraction of the detector volume, the strip pitch should be small compared to the thickness of the detector.

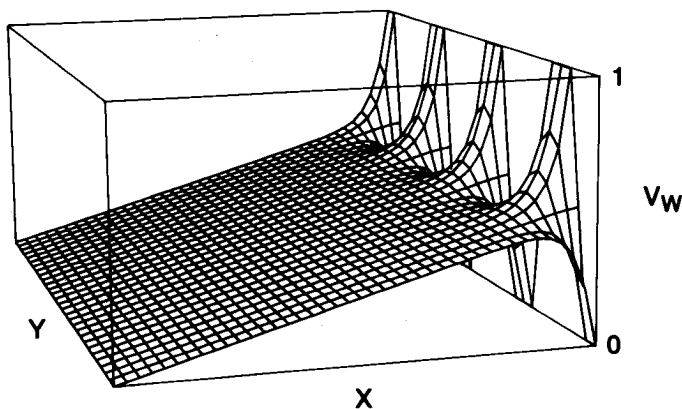

Figure 3. Weighing potential distribution for one of the grid electrodes in the coplanar grid configuration.

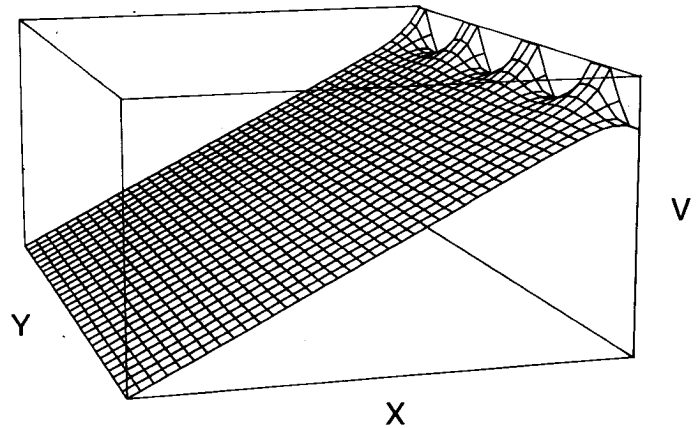

Figure 4. Calculated potential distribution in a coplanar grid detector with grid bias equal to one fifth the bias across the detector. The potential is shown for a positive charge.

In actual operation, the two grid electrodes need to be maintained at slightly different potentials so that carriers that are being collected toward the grid electrodes will be channeled to only one grid electrode. Otherwise, the difference signals can have either polarity and, more problematic, signal amplitudes will be reduced if carriers from a single event are shared among the two electrodes. The magnitude of the potential difference required depends primarily on the applied potential across the detector and the ratio of the strip pitch to the detector thickness. Typically, the strip pitch will be small so that the required potential difference will also be small compared to the overall potential across the detector and thus the electric field within the detector would remain substantially uniform. This is illustrated in Fig. 4, which shows the calculated potential distribution for the same detector geometry as that used for the weighing potential calculation, with a potential difference between the grids equal to one fifth of the average potential across the device.

III. EXPERIMENTAL PROCEDURES

A 5 mm x 5 mm x 5 mm CdZnTe detector [10] was used to evaluate the coplanar grid detection technique. The detector's charge collection characteristics and gamma-ray spectral response were first measured with the detector in a simple planar configuration. Thereafter, one of the electrodes was replaced with a set of 16 linear strip electrodes, which were formed by the evaporation of gold through a shadow mask. The width of each strip electrode was 0.15 mm and the strip pitch was 0.3 mm. Electrical connections to the strips were made through a series of spring loaded contacts. The contacts were interdigitally wired to give the two sets of grid electrodes.

The electronics used to implement the coplanar grid technique is shown schematically in Fig. 5. Two conventional AC-coupled charge-sensitive preamplifiers were used to measure the induced signals from the two grid electrodes. Signal subtraction was carried out with a simple circuit consisting of two operational amplifiers. A gain adjustment is provided to allow the relative gain of the two grid signals to

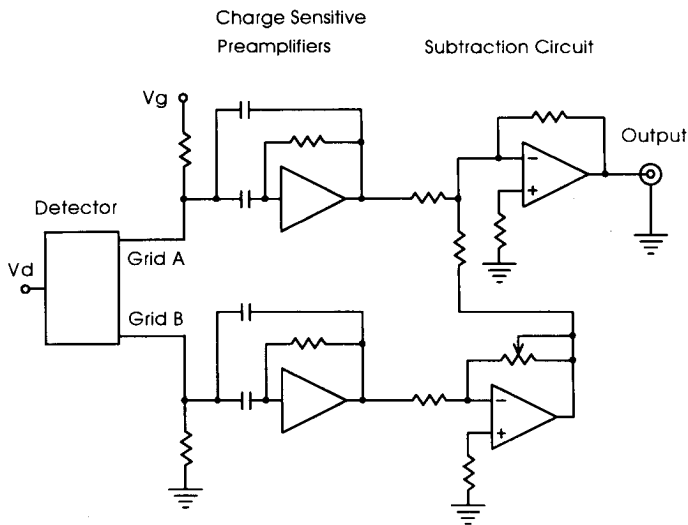

Fig. 5. Schematic of electronics used to implement the coplanar grid detection technique.

be varied. The output signal is then processed using standard electronics to obtain pulse height spectra. The detector bias (V_d) and grid bias (V_g) were supplied by two adjustable voltage sources. Since preferential electron sensing is desired, a negative detector bias was used so that electrons are collected toward the grid electrodes.

IV. EXPERIMENTAL RESULTS

A. Charge Collection

Signals from alpha particles were used to determine the charge collection properties of the CdZnTe material, with the detector in a simple planar configuration. Fig. 6a and 6b show the charge signals obtained when the alpha particles entered through the negatively biased electrode (electron collection) and the positively biased electrode (hole collection), respectively. The electron signals show a fairly linear rise and saturate abruptly at the point where the electrons reach the opposite electrode. This indicates that electrons are collected across the full thickness of the detector with good efficiency, although some trapping is evident. On the other hand, the hole signals have much longer rise times and greatly reduced amplitudes. The carrier mobility and lifetime for the electron are estimated to be $1000 \text{ cm}^2/\text{Vs}$ and $3.6 \mu\text{s}$, respectively, for the electrons; and $50 \text{ cm}^2/\text{Vs}$ and $5 \mu\text{s}$, respectively, for the holes. From this measurement, it can be seen that with typical pulse shaping times and detector bias voltages, holes contribute negligible signal and the detector can be characterized as essentially a single-polarity carrier (electron) collection device. This presents an ideal situation for evaluating the coplanar grid detection technique.

B. Spectral Response

With the detector in the simple planar configuration, the poor hole collection characteristics of the material gave rise to poor gamma ray spectral response, particularly for energetic gamma rays. As expected, a large enhancement of the spectral response resulted when the coplanar grid detection technique was applied. This is clearly illustrated in Fig. 7 and Fig. 8, which compare gamma-ray spectra obtained with the detector in the simple planar configuration and with the coplanar-grid detection technique. In the original ^{137}Cs spectrum (Fig. 7a), only a small photopeak can be seen while most of the events corresponding to full-energy absorption are distributed in a broad continuum due to the incomplete collection of holes. The additional background on top of this distribution is the Compton continuum, which is also distorted. No photopeak can be seen at all in the original ^{60}Co spectrum (Fig. 8a). In contrast, the spectra obtained using the coplanar grid technique show well-defined photopeaks and the Compton continua show the correct distributions (Fig. 7b and Fig. 8b). All four spectra were acquired with a detector bias of 480 V and a peaking time of $2 \mu\text{s}$. A grid bias (V_g) of 50 V was used in the coplanar grid measurement. The source-to-detector distance

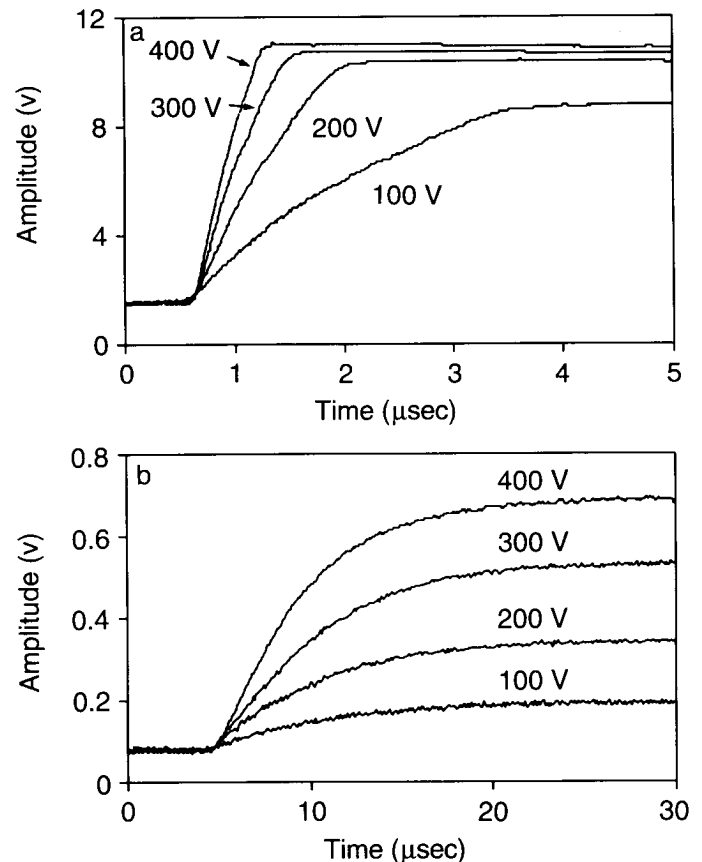

Fig. 6. Charge signals from alpha particles as a result of (a) electron collection and (b) hole collection.

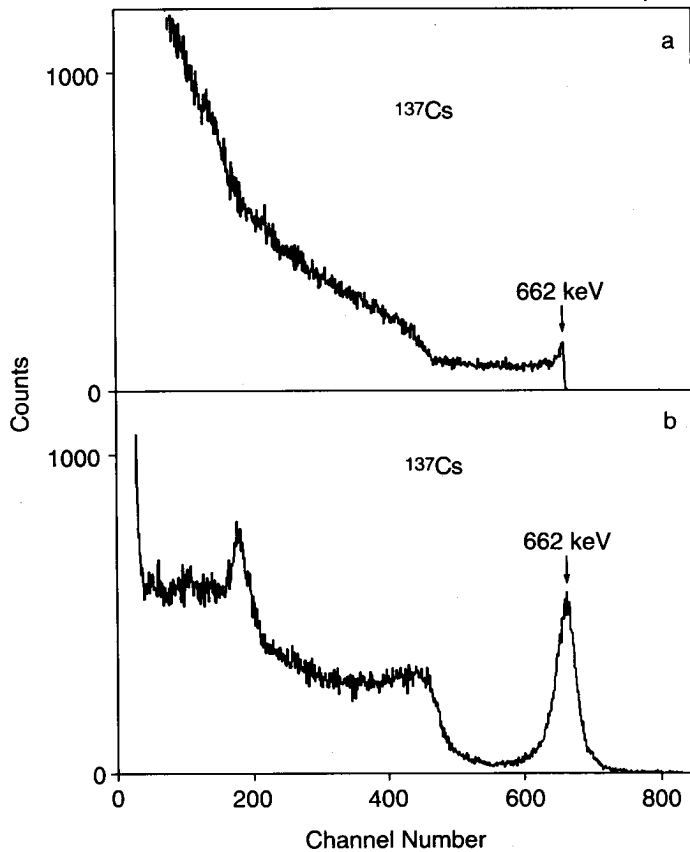

Fig. 7. ^{137}Cs spectra obtained (a) with the original detector and (b) using the coplanar grid detection technique. Detector bias was 480 V.

and counting times were kept the same. Since all signals were processed in the coplanar grid technique, detection efficiency was not compromised.

Spectra with better energy resolution have been obtained with higher detector bias. Fig. 9 shows a ^{137}Cs spectrum taken at $V_d=700$ V and $V_g=70$ V. Energy resolution at the 662 keV peak is 3.7%. Subtracting the contribution from electronic noise yields a net resolution of 3.1%. The electronic noise is dominated by noise associated with leakage current between the two grid electrodes. It is expected that this can be significantly reduced with improvements in device processing techniques.

The vast improvement in spectral performance obtained indicates that the coplanar-grid technique performs as expected and is very effective in eliminating the effects of poor hole collection. On the other hand, the best energy resolution obtained so far is still an order of magnitude worse than the theoretical resolution based on charge statistics considerations. There are many possible factors that can contribute to the broadening of spectral lines, such as electron trapping or spatial non-uniformity in electron trapping, asymmetry in the grid electrode structure, and edge effects. Further experimentation is needed to identify these resolution-limiting factors so that further improvements in energy resolution can be made.

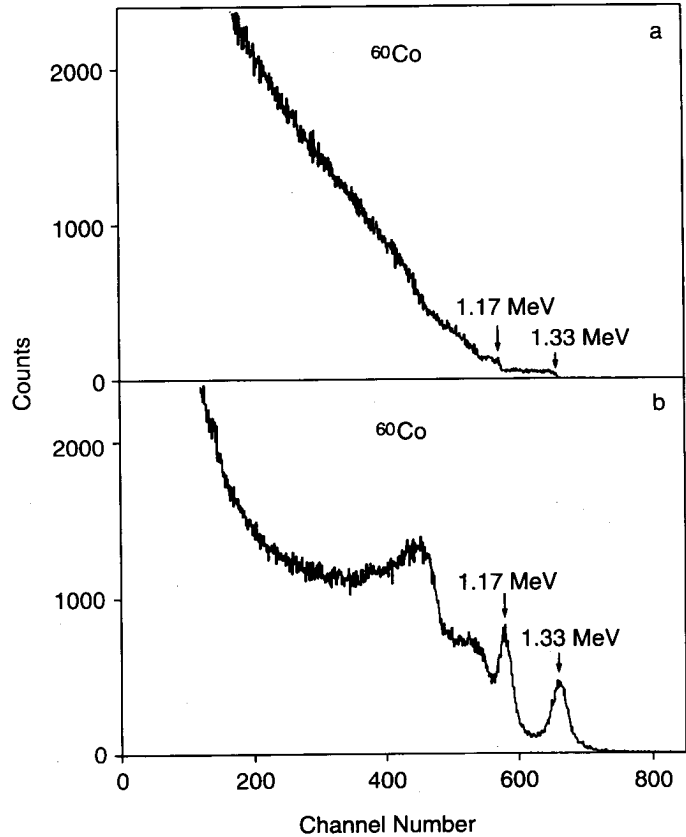

Fig. 8. ^{60}Co spectra obtained (a) with the original detector and (b) using the coplanar grid detection technique. Detector bias was 480.

C. Electron Trapping Correction and Position Sensitivity

Two important additional features of the coplanar grid detection method became apparent during the course of these experiments. One of these is the ability of the method to not only eliminate the effect of hole trapping but to also correct for electron trapping effects. Another feature is that position information can be readily derived from the available signals. These features can be understood by examining the signals from the two grid electrodes. Fig. 10 shows examples of signals captured simultaneously from the two grid electrodes while the detector was exposed to gamma rays from a ^{137}Cs source. The first set of signals (Fig. 10a) resembles the waveforms illustrated in Fig. 2, corresponding to the case where charge is created near the full area electrode. Fig. 10b shows a similar set of signals except that the initial portions of the signals appear to have been "truncated" compared to the first set of signals. This is because, in this case, the interaction occurred near the middle of the detector so that the electrons started their drift midway in the detector. Since there is negligible contribution from holes, the signal from the collecting grid is reduced in amplitude while the signal from the non-collecting grid becomes negative with respect to the baseline. As interactions occur at random locations in the

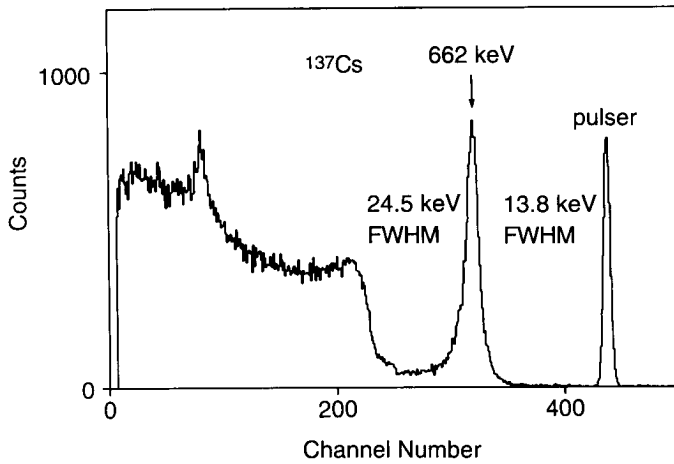

Fig. 9. ^{137}Cs spectrum obtained using the coplanar grid detection technique at a detector bias of 700 V.

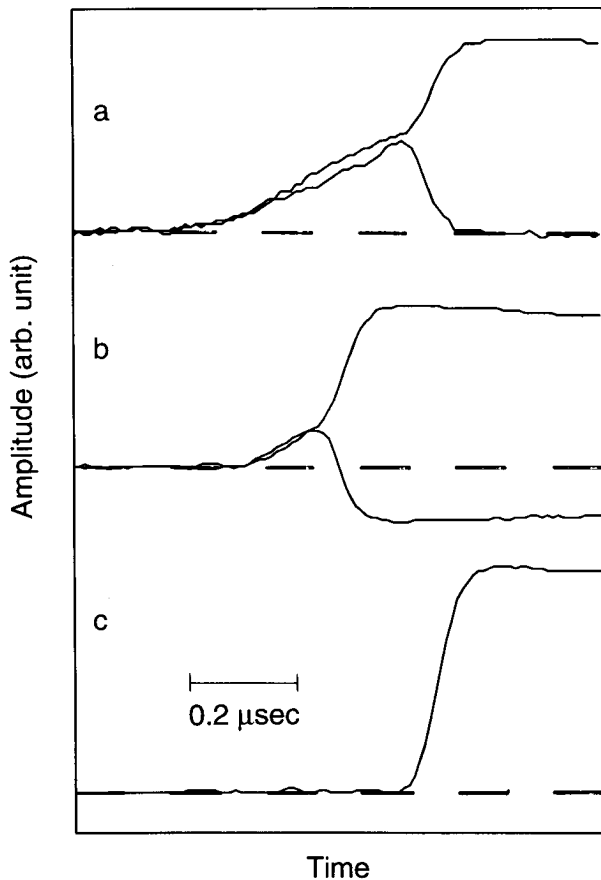

Fig. 10. (a,b) Charge signals captured simultaneously from the two grid electrodes. (c) A difference signal obtained from the output of the signal subtraction circuit. Dashed line (— — —) indicates baseline.

detector, signals with varying degrees of "truncation" can be seen and the final amplitudes of the two grid signals shift

randomly with respect to the baseline. The difference of the two grid signals, however, remains largely unaffected by these variations. Fig. 10c shows a difference signal captured from the output of the signal subtraction circuit.

Ideally, the relative gain of the two grid signals should be matched in order to produce the correct difference signal. However, this may not be optimal when electron trapping is present. When electrons are being trapped, the amplitude of the difference signal will decrease as the electron collection distance increases. The resulting variations in signal amplitude with respect to position directly affect the detector's energy resolution. From the above discussion, it can be seen that a larger part of the difference signal is derived from the non-collecting grid signal as the location of interaction moves closer to the grid electrodes. Therefore, by reducing the gain of the non-collecting grid signals from the ideal gain-matched condition, amplitude variations in the difference signals due to electron trapping can be cancelled out. Such a compensation effect was verified when it was observed that as the detector bias is lowered, which increased electron trapping, the gain of the non-collecting grid signal has to be reduced in order to maintain optimum energy resolution. Obviously, this method only provides a correction that is linear with respect to distance and is therefore effective only against electron trapping that is not too severe and is spatially uniform. Nevertheless, the ability to perform at least a first order correction greatly relaxes the material requirements in terms of electron collection efficiency.

The position-dependent shifts of the amplitudes of the two grid signals can also be exploited to determine the positions of radiation interactions. The ratio of the final amplitudes of the two grid signals relates directly to the depth of the interaction point. This method of position determination relies only on amplitude (charge) measurements and does not depend on signal timing. It is therefore insensitive to variations in carrier velocity due to changes in bias voltage or inhomogeneous distribution of carrier mobility and electric field in the detector.

It should be emphasized that negative polarity signals from the non-collecting grid are observed only when hole collection is incomplete. If holes are efficiently collected within the measurement time, there would be little or no net charge detected at the non-collecting grid (i.e., the signals will always return to the baseline) and the schemes for electron trapping correction or position sensing as described above would not function. This is one situation where poor hole collection, as found in the current CdZnTe materials, actually provides an advantage. On the other hand, the holes must not be trapped for extended periods of time as this could result in polarization effects. The absence of observable polarization effects in the present CdZnTe detector implies that the holes are eventually collected; the induced signals at the non-collecting grid ultimately return to zero, but this occurs on a time scale much longer than the measurement time employed.

V. CONCLUSION

The coplanar grid technique provides an effective method to sense the collection of carriers of one polarity type in ionization detectors so that poor collection of the opposite type carriers becomes unimportant. It closely emulates the function of Frisch grids and yet can be readily implemented on semiconductor detectors. The vast improvement in the spectral resolution obtained using a CdZnTe detector demonstrated the effectiveness of this technique. Significantly better resolution than that obtained so far is expected with further refinements in the coplanar grid technique combined with improvements in detector material. Detectors based on other compound semiconductors, virtually all of which suffer from poor hole collection, can also benefit from this technique. The electronics required are simple and amenable to miniaturization and low-power designs. This allows truly portable, battery-powered gamma-ray spectrometers to be realized using room-temperature semiconductor detectors. Additionally, this technique can be used in place of Frisch grids in gas ion chambers and liquid ionization detectors. The coplanar grid electrodes can be easily produced by, for example, patterning conductive traces on an insulating substrate. This simplifies detector construction and results in a more rugged detector structure. The coplanar grid technique also offers the capabilities for electron trapping correction and position-sensitive detection.

VI. REFERENCES

- [1] See, for example, papers in *Semiconductors for Room-Temperature Radiation Detector Applications, Proceedings of Material Research Society Symposium*, Vol. 302, April 12-16, 1993, San Francisco, CA, edited by R. B. James, T. E. Schlesinger, Paul Siffert and Larry Franks (Material Research Society, Pittsburgh, Pennsylvania, 1993).
- [2] J. F. Butler, C. L. Lingren and F. P. Doty, "Cd_{1-x}Zn_xTe Gamma Ray Detectors", *IEEE Trans. Nucl. Sci.*, Vol. 39, no. 4, pp. 605-609, Aug. 1992.
- [3] Elgin Eissler, private communication.
- [4] L. T. Jones and P. B. Woodlam, "Resolution Improvement in CdTe Gamma Detectors Using Pulse-Shape Discrimination", *Nucl. Instr. and Meth.*, Vol. 124, pp. 591-595, 1975.
- [5] M. Richter and P. Siffert, "High-Resolution Gamma-Ray Spectroscopy with CdTe Detector Systems", *Nucl. Instr. Meth.*, Vol. A322, pp. 529-537, 1992.
- [6] H. L. Malm, C. Canali, J. W. Mayer and M-A. Nicolet, "Gamma-Ray Spectroscopy with Single-Carrier Collection in High-Resistivity Semiconductors", *Appl. Phys. Lett.*, Vol. 26, No. 6, pp. 344-346, March 1975.
- [7] O. Frisch, British Atomic Energy Report BR-49 (1944).
- [8] P. N. Luke, "Single-Polarity Charge Sensing in Ionization Detectors using Coplanar Electrodes", to be published in *Appl. Phys. Lett.*, Nov. 1994.
- [9] S. Ramo, "Current Induced by Electron Motion", *Proc. IRE*, Vol. 27, pp.584-585, Sept. 1939.
- [10] Obtained from eV Products, Saxonburg, PA; specified as "spectrometer grade".